

DIMENSIONS: INCHES (+/-0.01)  
mm (+/-0.3)

CONTROLLER  
ENCLOSURE

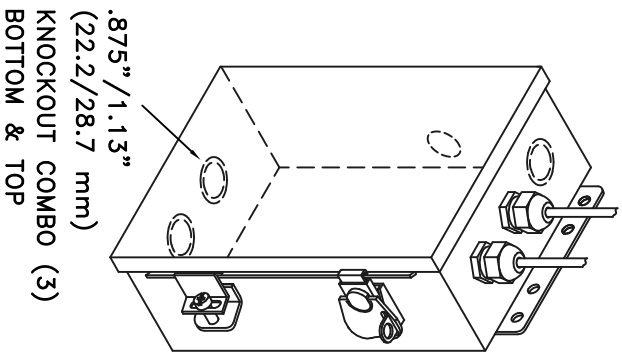

TWO-DIMENSIONAL  
ISOMETRIC VIEW

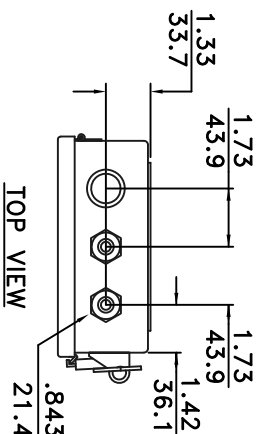

TOP VIEW

.843" THRU HOLE (2 PLCS)  
21.4 SEALED BY LIQUID-TIGHT CABLE GLAND FITTINGS

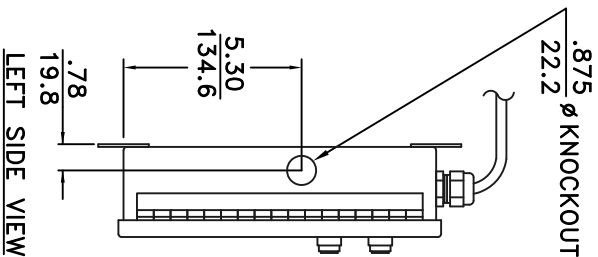

LEFT SIDE VIEW

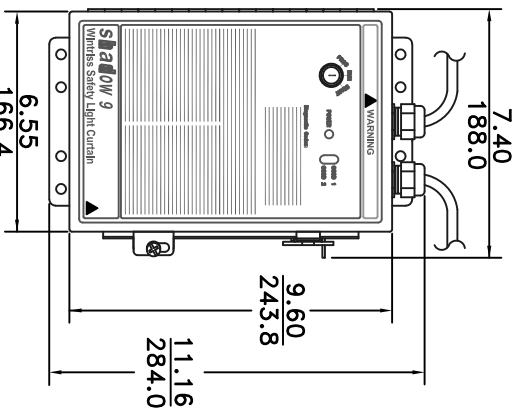

FRONT VIEW

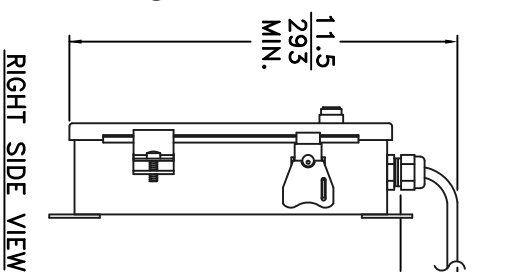

RIGHT SIDE VIEW

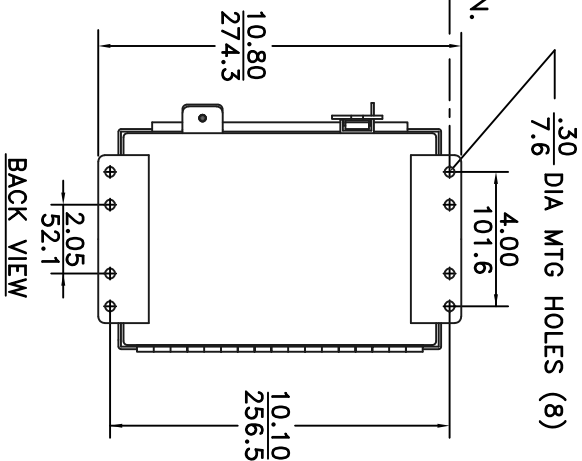

BACK VIEW

.875" / 1.13" Ø KNOCKOUT  
COMBO (3 PLCS)

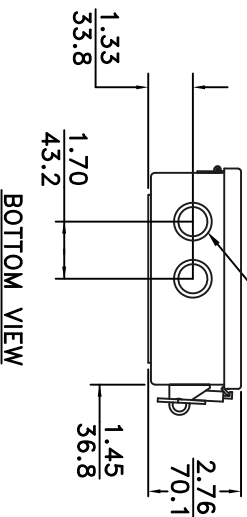

BOTTOM VIEW

DRAWN	RLM	DATE	11-21-17
CHK			
ENG.			
MFG.			
REL.			
APPROVALS		TITLE	
		Whittriss Controls Group	
FILE NAME		CODE IDENT. NO.	SIZE
SHADOW 9 CONTROL BOX			DRAWING NUMBER
			SHADOW 9 CONTROL BOX
SCALE		SHEET	1 OF 1